





# Occasional Furniture

**Page 2**

**Bar Cabinet**

**Page 4**

**Shoe Cabinet**

**Page 12**

**Study Room**

**Page 20**

**Home Seating**

**Page 24**

**Computer  
Workstation**

**Page 36**

**Study and  
Lounge**

---

**CARE BOOKLET**

Scan for tips on keeping  
your furniture at its best.



# Waltz Bar Cabinet

[View More](#) →

[Download PDF](#) ↓

### Features

- A distinctive design with functional storage for your bedroom or living space.
- Can store wine bottles, inverted glasses, beer bottles, and other products.
- Sheesham wood construction, supported by powder-coated metal legs.
- Comes as a part of the Waltz series furniture set, but can be used separately.

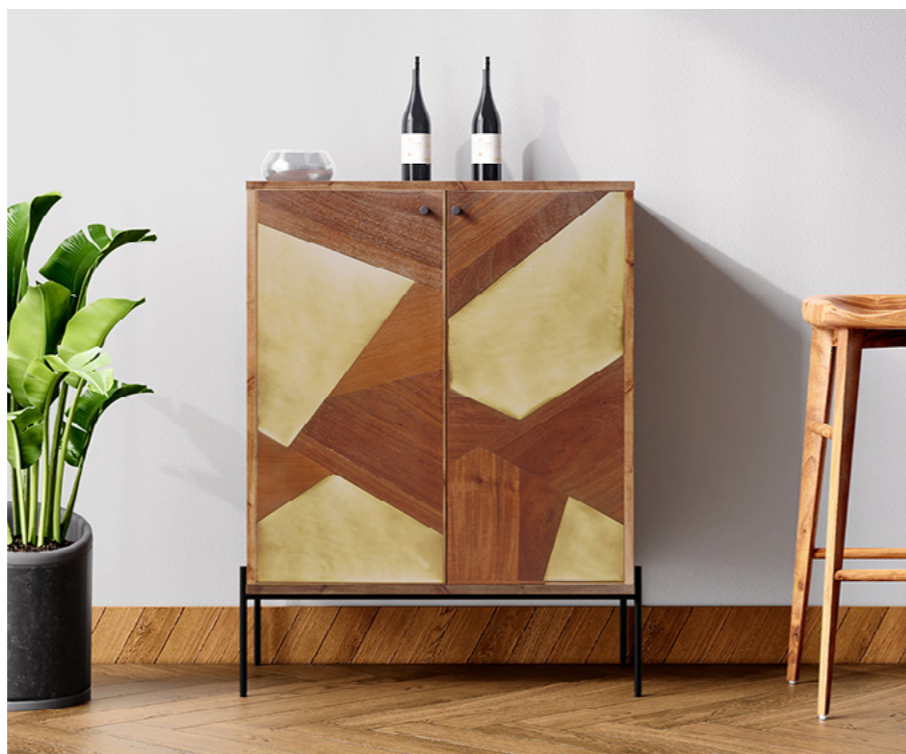

### Colour

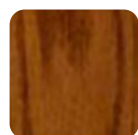

Antique Walnut

### Material

SHEESHAM WOOD

### Measurements



**DURA WOOD** Range of solid wood products



### Proportion

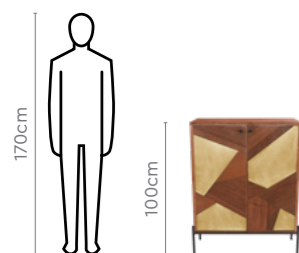

### Details



# Tyrion Bar Cabinet

[View More](#) →

[Download PDF](#) ↓

### Features

- A compact and stylish cabinet for those with a taste for good times and and classy furniture.
- Compartments with vertical and horizontal storage keep your bottles safe.
- Dura-wood (Sheesham) construction with Stone Grey finish gives the cabinet a unique look.



### Colour

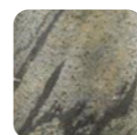

Stone Grey

### Material

SHEESHAM WOOD

### Measurements



**DURA WOOD** Range of solid wood products

### Proportion

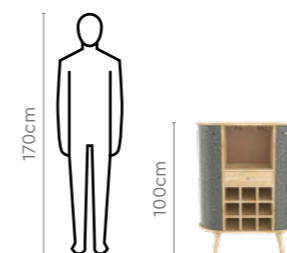

### Details

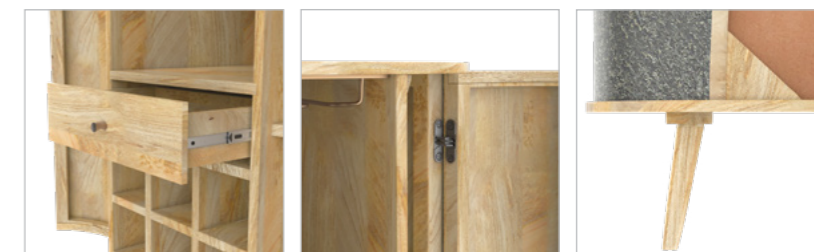

# S29 2.0 Shoe Cabinet

[View More](#) →

[Download PDF](#) ↓

## Features

- An important product for every home, this shoe cabinet can store up to 29 pairs of regular-sized footwear.
- The main unit consists of five fixed shelves, and the seating unit consists of two.
- Fixed shelves are tilted at an angle and placed at an adequate distance from each other.
- Comfortable seating cushion on the top allows you to use the cabinet while wearing or removing your shoes.
- Apt for compact homes.



## Colour



Fab Grey

## Material

ENGINEERED WOOD

## Measurements

Shoe Cabinet &amp; Cushion

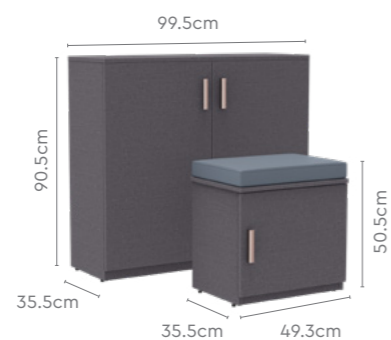

## Proportion

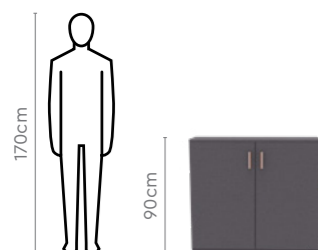

## Details

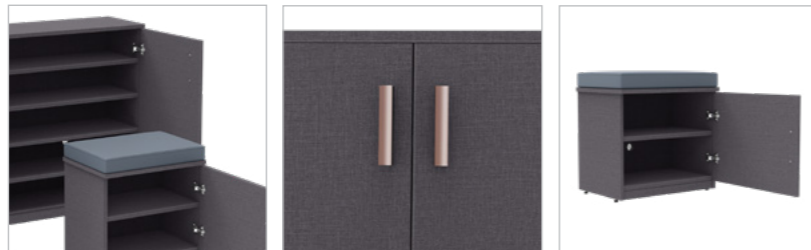

# Meraki Shoe Cabinet

[Click to Purchase](#) 🛒

[Download PDF](#) ↓

## Features

- This shoe cabinet is big on functionality, and comes with a clean design and minimal details. It also provides ample space for footwear.
- Part of the Meraki furniture family, it can be used in living spaces to complement other Meraki pieces.
- Its compact design makes it easy to be placed anywhere in the room, and the wood finish helps it blend with all types of interior styles.

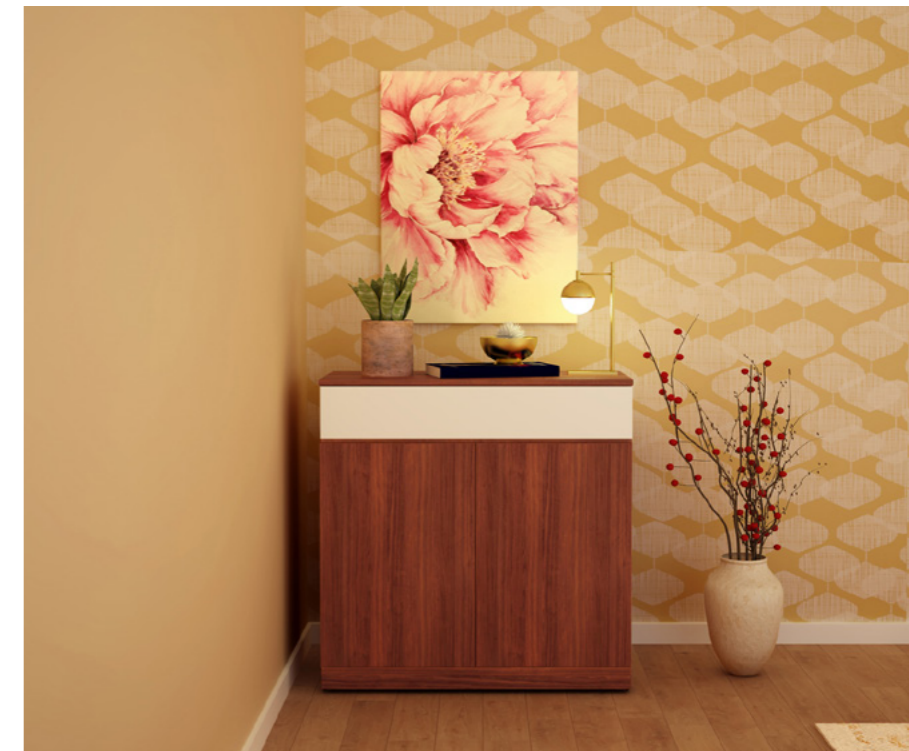

## Colour



Brown &amp; Beige

## Material

ENGINEERED WOOD

## Measurements



## Proportion

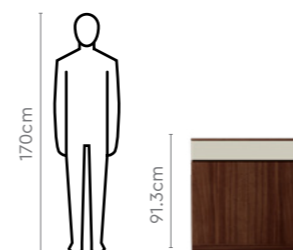

## Details



# Step-in Tier Shoe Cabinet

[Click to Purchase](#)

[Download PDF](#)

### Features

- A compact and durable solution for modern homes with little space for a free-standing shoe rack.
- Made of CRCA steel, it can be wall-mounted using the teardrop holes present in the back. This shoe cabinet is apt for corridors inside a home or places outside like balconies.
- Doesn't occupy floor space and has vents at the bottom for ventilation to remove odour from footwear.

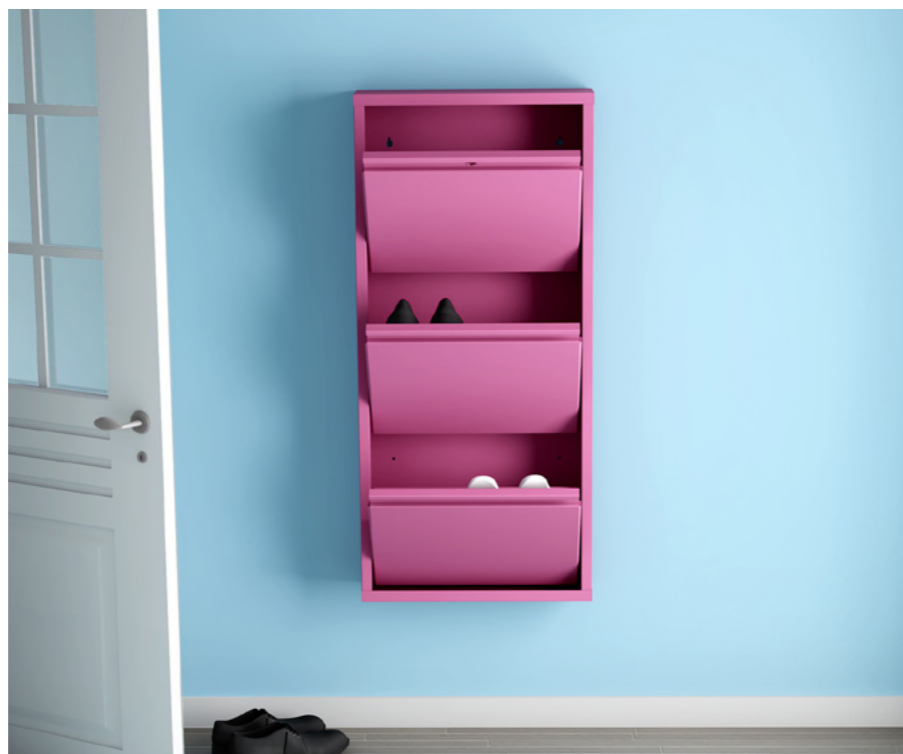

### Colour

AVAILABLE IN M SIZE

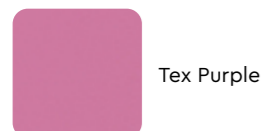

AVAILABLE IN L & XL SIZE

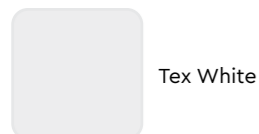

### Measurements

M SIZE

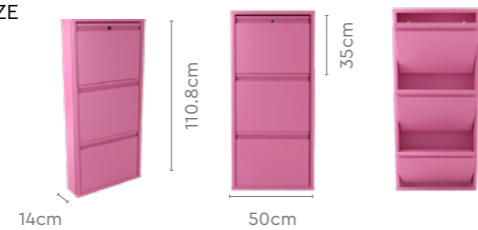

L SIZE



XL SIZE

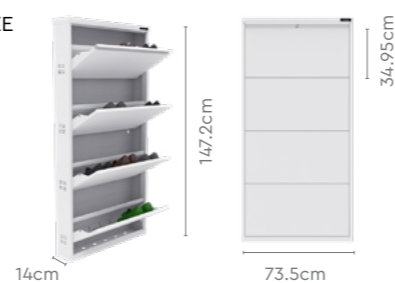

### Material

METAL

### Details

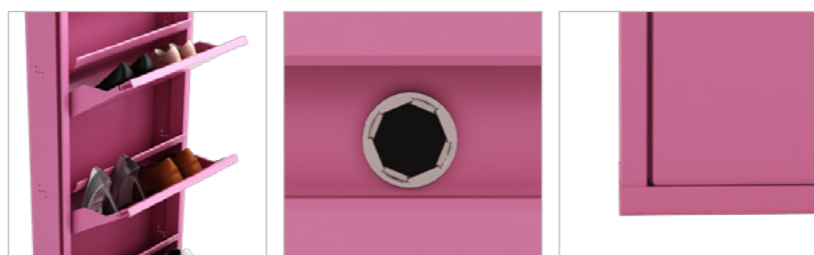

# Shoe Cabinet 203M

[View More](#)

[Download PDF](#)

### Features

- Compact shoe cabinet with a soft cushion top to sit on while wearing or removing shoes.
- Built with a special Melamine Faced Chipboard that adds to the product's durability.
- Comes in different size options as a product family and can be combined with smaller cabinets.



### Colour

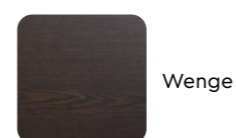

### Measurements



### Material

ENGINEERED WOOD

Pair with

**Shoe Cabinet 202M Advance**

[→ Pg 8](#)



### Proportion

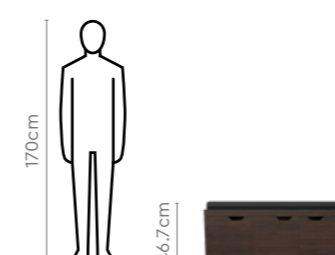

### Details



# Shoe Cabinet 202M Advance

[View More](#) →

[Download PDF](#) ↓

## Features

- A smaller variant of 203M Ind cabinet series, that's perfect for compact rooms and foyer areas.
- This warm wood-finished product can also be used as a small seating unit in living space, as it comes with a soft cushion on top.
- Built with a special Melamine Faced Chipboard that adds to the product's durability.



## Colour



Wenge

## Measurements



## Material

ENGINEERED WOOD

Pair with

**Shoe Cabinet  
203M Ind**
[→ Pg 7](#)

## Proportion

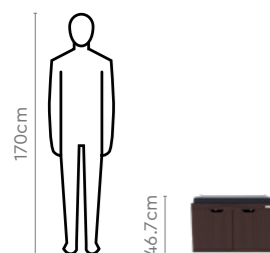

## Details

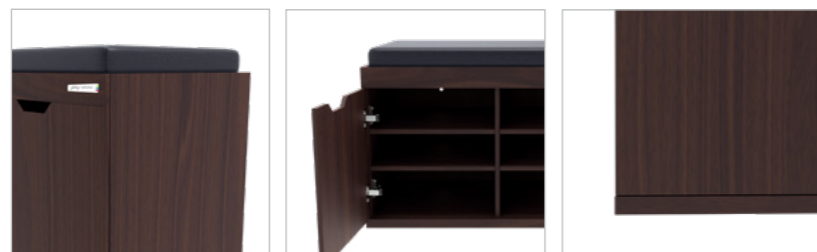

# Brogan Shoe Cabinet

[Click to Purchase](#) 🛒

[Download PDF](#) ↓

## Features

- Tall, slim shoe rack saves on floor space and works well in foyer and bedroom settings.
- Compact rack uniquely designed to store 30 pairs of shoes.
- Adjustable shelves accommodate shoes of all shapes and sizes.
- Comes with multi-utility drawers and locked cabinets.
- Made-in-Germany hardware enhances durability.



## Colour

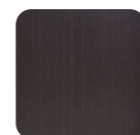

Colarain

## Measurements

Brogan Tall



## Material

ENGINEERED WOOD

## Proportion

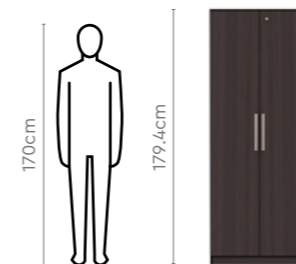

## Details



# Footy Shoe Cabinet

[View More](#) →

[Download PDF](#) ↓

## Features

- Designed with horizontal grain wood finish to blend aesthetically with modern or traditional interiors.
- Top surface shelf can be used as a docking point or display space.
- Adjustable shelves accommodate 15 to 20 pairs of adult shoes.
- Ventilation holes allow moisture to escape and reduce odour.



## Colour



Walnut

## Material

ENGINEERED WOOD

## Measurements



## Proportion

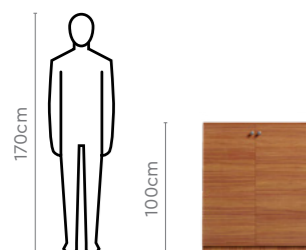

## Details



# Sienna Shoe Cabinet

[Click to Purchase](#) 🛒

[Download PDF](#) ↓

## Features

- A tall, attractive shoe rack that fits into corners or ends of hallways.
- The storage cabinet at the top tucks away parcels, umbrellas, and shopping bags.
- The open display space in the middle is handy for storing keys and other knick-knacks.
- Easy to maintain. All it requires is regular wiping with a soft, thick cloth.



## Colour

Warm Grey  
& Cinnamon

## Material

WOOD

## Measurements



## Proportion

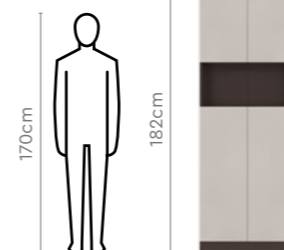

## Details

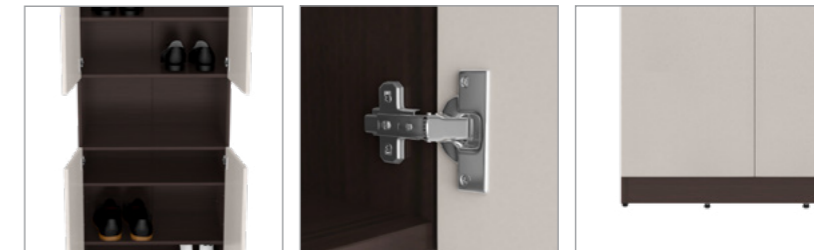

# Adria Workdesk & Study Table

[Click to Purchase](#)

[Download PDF](#)

### Features

- With an ultra-sleek design, this table can be placed in any corner of the house, be it in your study, bedroom, or home office.
- Its large tabletop can easily accommodate laptops and accessories, making it an ideal workstation.
- Comes with a compact storage drawer that allows you to keep your stationery organised.



### Colour



Imperial Oak

### Material

ENGINEERED WOOD

### Measurements

Workdesk

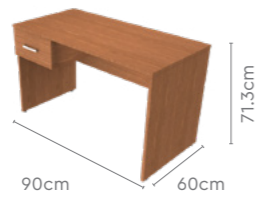

Study Table

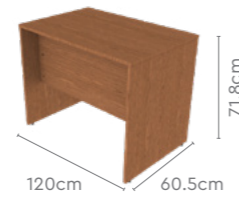

Pair with

**Adria Bed Set**

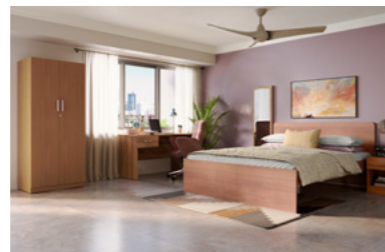

**Tufty® Chair**

→ Pg 23



### Proportion

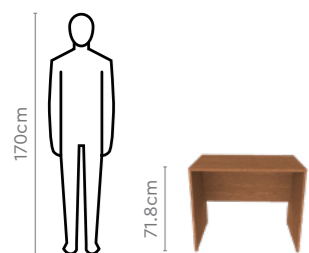

### Details



# Uno Study Table

[Click to Purchase](#)

[Download PDF](#)

### Features

- A clean and contemporary study table, with an open shelf and drawer, that caters to the different members of a family and their individual needs.
- The tabletop can be used for work or reading, and as a flat surface to keep your accessories, potted plants, and other such items.
- Comes with ample open space underneath, which provides comfortable leg room and seating for long working hours.



### Colour



Granite Black

### Material

ENGINEERED WOOD

### Measurements



Pair with

**Virtue Work Chair**

→ Pg 22



### Proportion

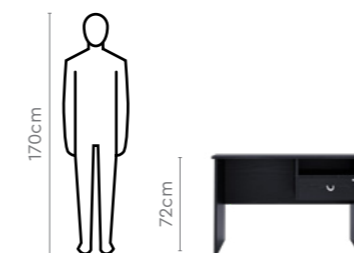

### Details





# Chocolate V2 Study Table

[Click to Purchase](#)
[Download PDF](#)

## Features

- Part of the Chocolate V2 product family, this table is ideal for bedrooms and study or home office.
- With two drawers, the table provides ample storage space for stationery, documents, and other related items.
- Pair it with the bedroom set and wardrobe from the Chocolate V2 product family, and give your bedroom a consistent look and feel.



## Colour



Cola Rain

## Material

ENGINEERED WOOD

## Measurements

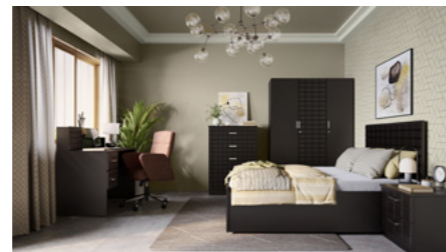

Pair with

**Chocolate V2  
Bed Set**

## Proportion

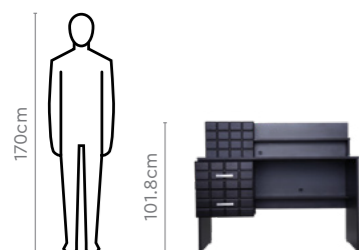

## Details



# Squadro V2 Study Table

[Click to Purchase](#)
[Download PDF](#)

## Features

- Study table with ample tabletop space to accommodate laptop and books, and two drawers for additional storage.
- Comes under the Squadro V2 product family, and can be placed in a bedroom or study with matching furniture products.
- Light, durable, and comfortable for long working hours.



## Colour



Cinnamon

## Material

ENGINEERED WOOD

## Measurements



Pair with

**Squadro V2  
Bed Set**

## Proportion

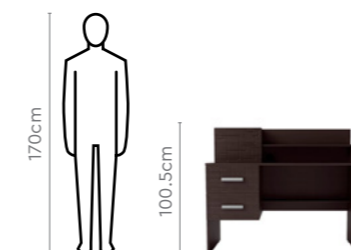

## Details



# Floyd Study Table

[Click to Purchase](#)

[Download PDF](#)

## Features

- Made for small and compact spaces, this table is ideal for a bedroom or a study room.
- Comes with a classic wooden finish that blends with all types of interior styles and décor.
- A handleless door makes the product easy to use for kids and elders alike.
- Can be combined with the Floyd bed for a complete and complementary space.



Design Registration No.: 256403

## Colour



Valigny Oak

## Material

ENGINEERED WOOD

## Measurements



Pair with

**Poise Work Chair**

[→ Pg 21](#)



**Virtue Work Chair**

[→ Pg 22](#)



## Proportion

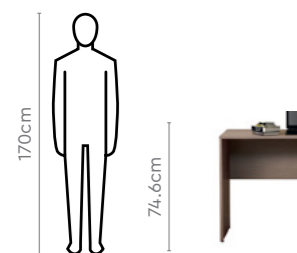

## Details



# EQ Study Table

[Click to Purchase](#)

[Download PDF](#)

## Features

- A stylish addition to your study room, home office, or bedroom.
- With angular legs and a strong tabletop, this study table is ideal for corner spaces as it doesn't take up much space.
- Can be used for reading, working on a laptop, or even just as a space to keep your accessories or books. Comes with an attached storage drawer to organize your stationery.



## Colour



Cinnamon & Taupe White

## Material

ENGINEERED WOOD + METAL

## Measurements



Pair with

**Poise Work Chair**

[→ Pg 21](#)



**Virtue Work Chair**

[→ Pg 22](#)



## Proportion

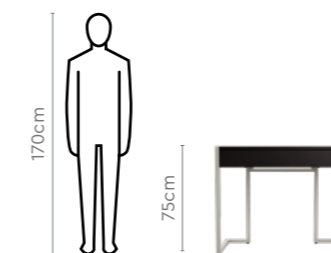

## Details

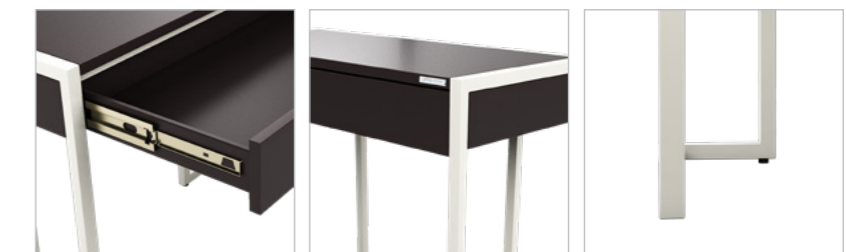

# Float Study Table

[View More →](#)
[Download PDF ↓](#)

## Features

- Modern, functional design created with bent plywood aesthetically used to create a workspace ecosystem that is calm and clutter-free.
- Ample desktop space with side hooks for hanging laptop bag.
- Lids convert to laptop/tablet stands, trays, and coasters.
- Floating storage holds books, stationery, or decorative items.



## Colour



Ash

## Material

WOOD

## Measurements

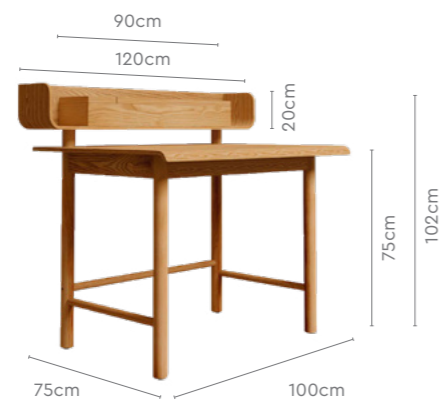

## Proportion

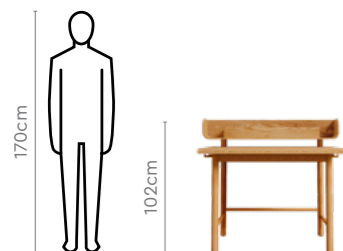

## Details



# Excella Study Table

[View More →](#)
[Download PDF ↓](#)

## Features

- The Excella Study table promotes a healthy and productive work environment.
- Easily adjust height to preferred working position, reducing strain on back, neck, and shoulders.
- Built-in wire management keeps cables organised and hidden.
- Can be used as a workspace, study space, or sleek hobby station.
- Sturdy, durable construction.



## Colour



Maple

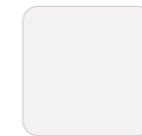

White

## Material

ENGINEERED WOOD + METAL

## Measurements



## Proportion

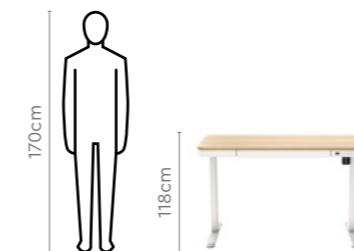

## Details



# Aircon

[Click to Purchase](#)
[Download PDF](#)

## Features

- With thick cushioning in the seat, this chair gives sofa-like comfort in an ergonomic chair design. Designed specially for WFH environments.
- The back is designed in a dual finish that not only enhances its aesthetics, but also keeps it breezy.
- Engulfed support at the back keeps you rested during long working hours.



## Colour



## Measurements



## Material

SYNTHETIC LEATHER

Pair with

**Chocolate V2 Study Table**  
→ Pg 14



## Proportion

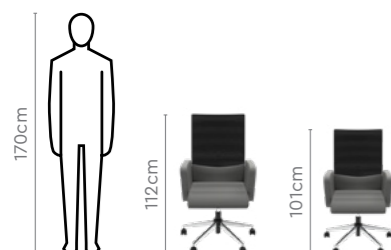

## Details



# Poise Work Chair

[Click to Purchase](#)
[Download PDF](#)

## Features

- An adjustable work chair with a tilt mechanism for maximum comfort while being seated.
- The deep seat provides generous space to sit and work for long hours, while the premium net back gives a snug feel and helps maintain correct posture.
- Height adjustment feature provides more flexibility, and a strong metal base with wheels makes for easy movement.



## Colour



## Material

FABRIC

## Proportion

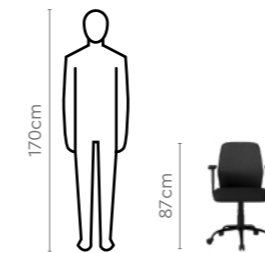

## Measurements



## Proportion

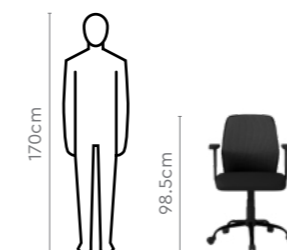

## Details

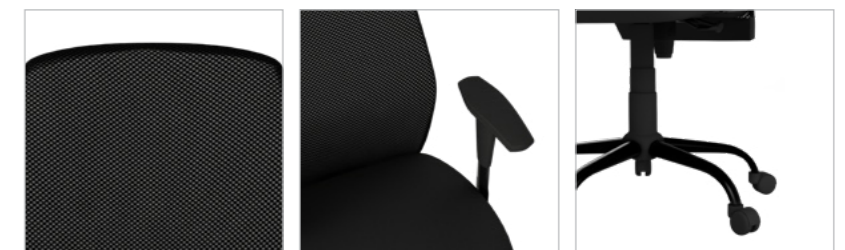

# Virtue Work Chair

[Click to Purchase](#)
[Download PDF](#)

## Features

- Designed for long hours of seating with lumbar support ideal for WFH scenario.
- Comfortable, cushioned seat with a strong metal base with wheels provides comfort and flexibility.
- Can be matched with any Godrej Interio study table or workstation, because of its basic neutral look.



## Colour



Black

## Material

SYNTHETIC LEATHER + FABRIC

## Proportion

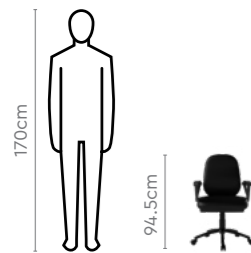

## Measurements

Leatherette and Fabric Chair



## Proportion

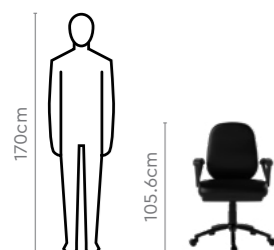

## Details

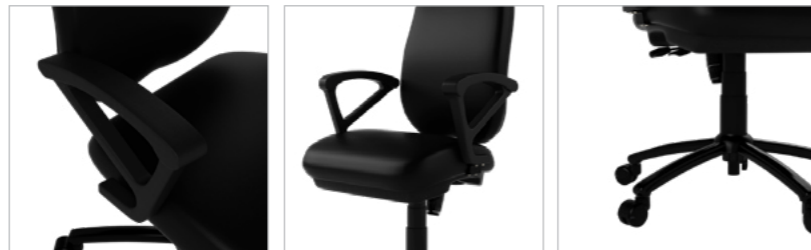

# Tufty® Chair

[Click to Purchase](#)
[Download PDF](#)

## Features

- Plush with cushioning on the seat and back, this chair provides the executive office experience at home.
- Contoured back offers extra lumbar support for long working hours.
- Chrome base with wheels enhances the sleek look while maintaining the comfort of working.



## Colour



Saddle Brown



Ash Grey

## Material

SYNTHETIC LEATHER

## Measurements



## Proportion



## Details



# Caliber 201

[Click to Purchase](#) 

[Download PDF](#) 

## Features

- A small compact workstation that can be fitted in any corner of your home.
- Ideal for students and elders alike, as the tabletop provides ample space to accommodate a laptop or books and stationery.
- Comes with a footrest for comfortable long hours of seating, and wheels for easy mobility.



## Colour



Red Maple

## Measurements



## Material

ENGINEERED WOOD

Pair with

**Poise Work Chair**

[→ Pg 21](#)



## Proportion

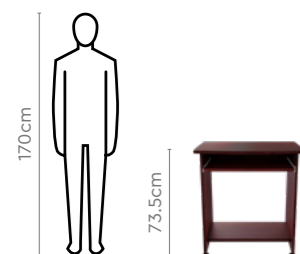

## Details

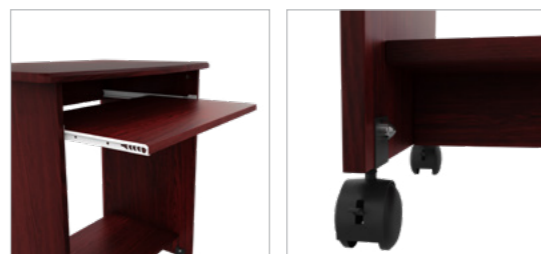

# Caliber 202

[Click to Purchase](#) 

[Download PDF](#) 

## Features

- Classic, compact structural design that can be placed in any room or corner, as it takes up less space.
- Additional storage in the bottom for organising files, documents, and stationery.



## Colour

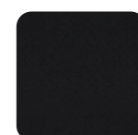

Black

## Measurements



## Material

ENGINEERED WOOD

Pair with

**Poise Work Chair**

[→ Pg 21](#)



## Proportion

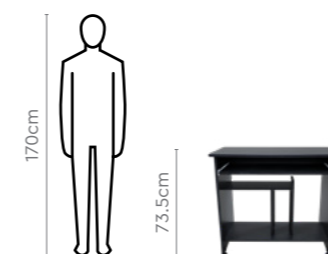

## Details



# Caliber 203

[Click to Purchase](#)
[Download PDF](#)

## Features

- Contemporary-looking member from the Caliber product family, with a wooden tabletop and metal understructure.
- Undershelves provide space for storing books and documents, and the tabletop can hold a laptop or a monitor.
- Footrest makes long working or studying hours comfortable.



## Colour



Yellow Walnut



Grey

## Measurements



## Material

ENGINEERED WOOD + METAL

Pair with

**Poise  
Work  
Chair**
[→ Pg 21](#)

## Proportion

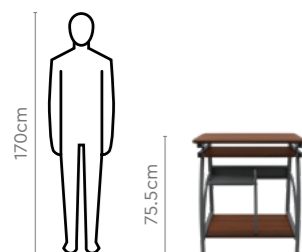

## Details



# Companion C2 Advance

[Click to Purchase](#)
[Download PDF](#)

## Features

- A simple and minimal design that belongs to the Companion product family.
- The table comes with wheels, which makes it easy to move from one room to another.
- The large tabletop comes with a cable grommet for cable management.
- Storage drawer and an undershelf helps organize your documents and stationery better.



## Colour



Beech

## Material

ENGINEERED WOOD

## Measurements



## Proportion

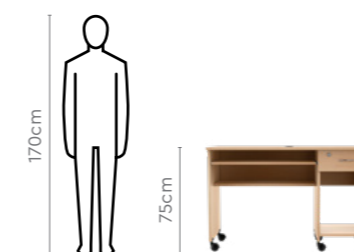

## Details



# Companion C9 Advance

[Click to Purchase](#)

[Download PDF](#)

## Features

- A more open variant of the Companion product family.
- The table comes with a keyboard or writing shelf on slides, making it ideal for reading and writing.
- Undershelves provide space for documents, files, and even décor items.



## Colour

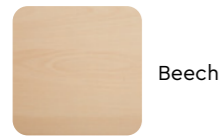

## Measurements



## Material

ENGINEERED WOOD

Pair with

**Poise Work Chair**

[→ Pg 21](#)



## Proportion

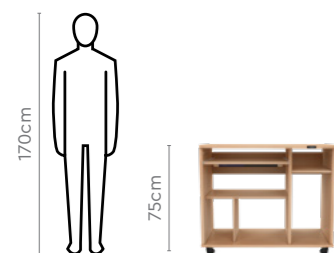

## Details



# Companion C10 Advance

[View More](#)

[Download PDF](#)

## Features

- This sleek table is part of the Companion product line, a collection of compact, sophisticated and practical workstations.
- A space-saving computer table with a built-in keyboard tray and a compact pull-out tray for the mouse.
- Easily accommodates CPU and offers two additional open shelves for stationery.
- The table is equipped with lockable castors, allowing for easy mobility.
- Ideal for small, compact, or limited spaces.



## Colour

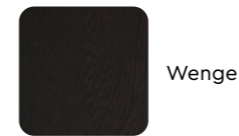

## Measurements



## Material

ENGINEERED WOOD

Pair with

**Virtue Work Chair**

[→ Pg 22](#)



## Proportion

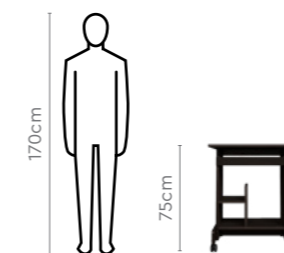

## Details

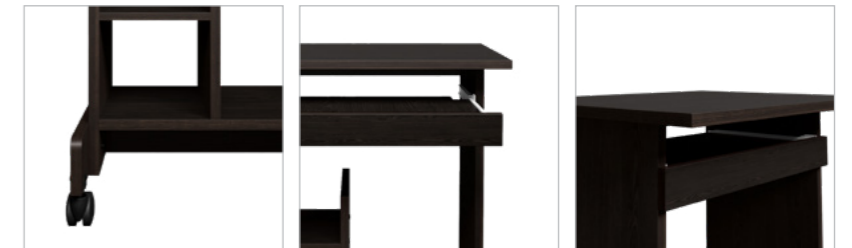



# Companion C11 Advance

[View More](#) →

[Download PDF](#) ↓

## Features

- This computer table provides ample workspace, generous storage, and a convenient built-in keyboard tray.
- The tabletop is designed to accommodate a laptop or monitor, with space for books and papers. The CPU easily fits on the bottom shelf.
- The desk has two drawers and two open shelves that make cable management neat and easy.
- Lockable castors enhance portability from one room to another.
- Perfect in any office or home setting.



## Colour

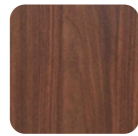

Walnut

## Material

ENGINEERED WOOD

## Measurements



Pair with

**Virtue  
Work  
Chair**

→ Pg 22



## Proportion

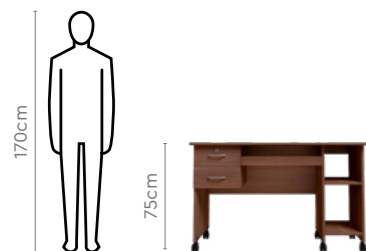

## Details

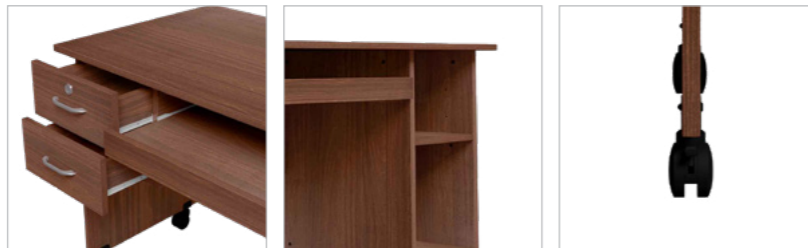

# Companion C13

[View More](#) →

[Download PDF](#) ↓

## Features

- Compact work table with a full side cabinet for maximum storage and tidiness.
- Available in a Wenge finish, this product can blend with any type of interior style.
- Small shelf on the tabletop can be used to organize books or place décor items.
- Undershelf and a reading shelf on slides makes for comfortable long hours of uninterrupted work.



## Colour



Wenge

## Material

ENGINEERED WOOD

## Measurements



Pair with

**Poise  
Work  
Chair**

→ Pg 21



## Proportion

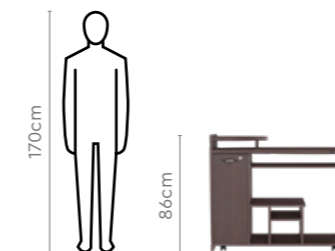

## Details



# Buddy

[Click to Purchase](#)

[Download PDF](#)

### Features

- A lightweight and compact solution for youngsters and elders alike.
- Open leg space and a metal understructure makes the table sturdy and comfortable.
- Can fit into any corner of your home or office.



### Colour



### Measurements

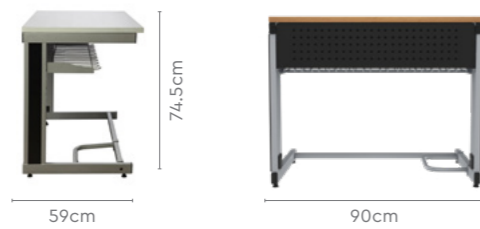

Pair with

**Poise Work Chair**

[→ Pg 21](#)



### Material

ENGINEERED WOOD + METAL

### Proportion

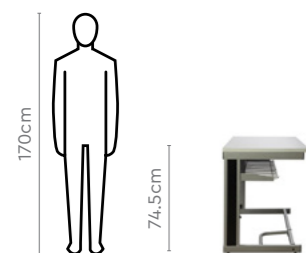

### Details



# Target 104

[Click to Purchase](#)

[Download PDF](#)

### Features

- Dual storage sections with drawers and cabinets provide ample space to organise work-related documents and accessories.
- The large tabletop can accommodate laptops and monitors for an easy and ergonomic workflow.
- Central space is open for comfortable seating.



### Colour

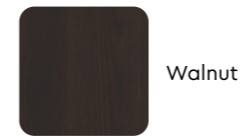

### Measurements

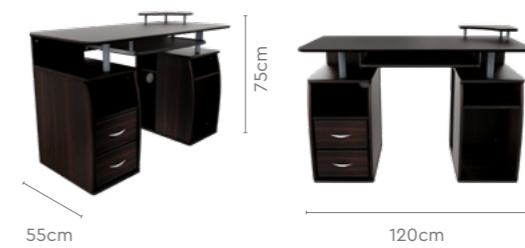

Pair with

**Poise Work Chair**

[→ Pg 21](#)



### Material

ENGINEERED WOOD

### Proportion

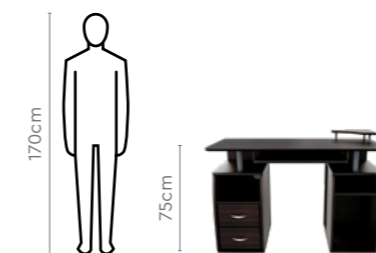

### Details



# Akira

Click to Purchase 

Download PDF 

## Features

- One of the perfect WFH pieces for urban apartments, Akira is designed to cater to the current work needs.
- Unfolds to become a full-fledged work desk and is suited for bedrooms, study, or even living rooms.
- Inside the desk are utility features of white board and magnetic board to help you take quick notes.
- Provision for wire management system in the upper-level shelf.
- Overall, the display space can be used for showcasing memories or even indoor plants.



Design Registration No.: 332830-001

## Colour

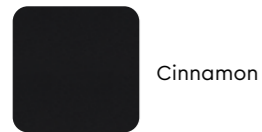

Cinnamon

## Material

ENGINEERED WOOD

## Measurements



Pair with

**Poise Work Chair**

[→ Pg 21](#)



## Proportion

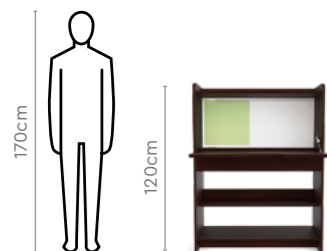

## Details

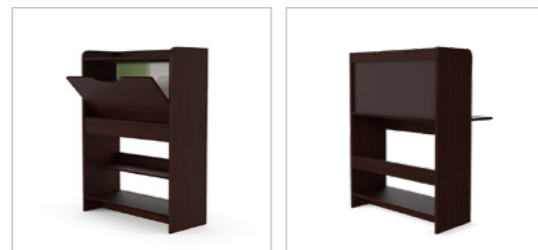

# Bay

Click to Purchase 

Download PDF 

## Features

- Ideal for those who prefer to work/study in the bedroom, and want to have the option of sitting on the bed and working too.
- Designed to offer flexibility, the swivelling laptop support arm allows you to dock your laptop on the support arm when the table is positioned next to a bed.
- Overhead storage with sliding shutter allows you to stow away objects and also display your collection of books, uniquely.



## Colour



Noce Versailles

## Material

ENGINEERED WOOD

## Measurements



Pair with

**Poise Work Chair**

[→ Pg 21](#)



## Proportion

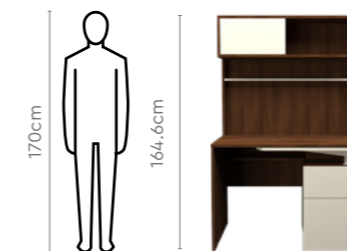

## Details

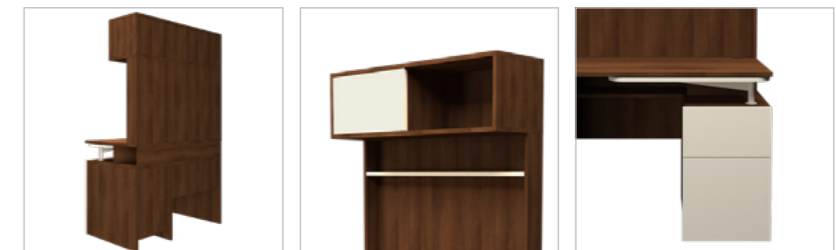

# Hood

[View More](#) →[Download PDF](#) ↓

## Features

- A sleek, aesthetically pleasing and sturdy desk with an asymmetric top design. It has a unique curved shelf on the tabletop that lends to its name — Hood.
- The top curved shelf acts as space to keep stationery, laptop, and accessories.
- It gets its unique look as it's made from bent plywood, and its solid rubber wood legs provide stability to the structure.
- Comes with an additional drawer storage under the tabletop for keeping documents and small items.



## Colour

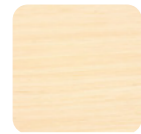

Natural Ash

## Material

ENGINEERED WOOD

## Measurements



Pair with

**Virtue  
Work  
Chair**

→ Pg 22



## Proportion

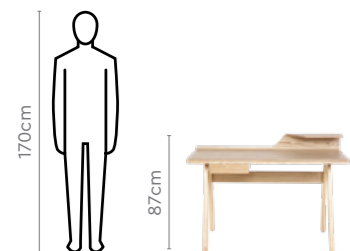

## Details

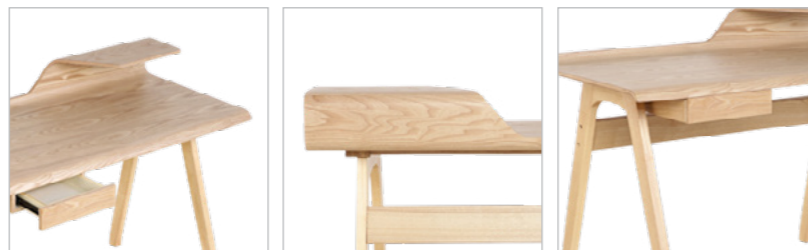



Available in 600 locations in India.

**North:** Delhi, Chandigarh, NCR, Lucknow

**South:** Chennai, Bengaluru, Hyderabad, Kochi

**West:** Mumbai, Ahmedabad, Bhopal, Pune

**East:** Kolkata, Bhubaneswar, Guwahati, Patna

**Godrej & Boyce Mfg. Co. Ltd.**

Godrej Interio,  
Pirojshanagar, Vikhroli (W),  
Mumbai 400 079

**Toll Free Number:** 1800-209-5511

**Email:** sales@godrej.com

**Website:** www.godrejinterio.com

B2CHMERNGECOCT24

godrejinterio.com



**TRA Research**  
India's  
Most Trusted Brand  
2022  
Furniture Category



**Indian Sleep  
Products Federation**  
Member of  
Indian Sleep  
Products Federation



**Marksmen Daily**  
Most Preferred Brand  
2022



**Marksmen Daily**  
Most Trusted Brands  
of India  
2024 - 2025



**India's Retail  
Champions Awards**  
Champion  
2024



**Franchise India**  
Retail Brand of the Year  
2022  
Speciality/Furniture  
Retail Category



**The Economic Times**  
Best Brands®  
2022



**Marksmen Daily**  
Brand Of The Year  
2023 - 2024



**ET Now**  
Iconic Brands of India  
2024

Godrej interio  
**talk green.**  
**walk green.**

An initiative by Godrej Interio,  
the first Indian furniture company  
with GREENGUARD certified products.

MODULAR FURNITURE . DESKING . SEATING . STORAGE . INTERIORS . LAB . HEALTHCARE . HOME

Follow us on /godrejinterio



The GREENGUARD Certification Program gives assurance that products designed for use in indoor spaces meet strict chemical emission limits, which create healthier interiors. The certification qualifies for LEED credits and IGBC credits.

In keeping with the Godrej policy of continuous development and improvement, the design, dimension and specification may be updated without prior notice or obligations. Form, Colour and Finish of product in this document are representative of design intent and may vary from actual. Colour options depicted in this catalogue are as close to what modern printing processes allow. All dimensions are in 'cm' and are subject to commercial tolerance. Our products are meant for indoor use only.